

Panel Technical Specifications



Play with light

Wood & Washi Panel offers a range of options allowing the management of the desired view and light due to the possibility of moving every screen left or right.

Wood & Washi Panel is available in almost any desired width and height. The screens are offered with 1 to 5 intervals, with the gaps being evenly distributed over the height. It is also possible to apply ribs at any desired distance or add extra ribs.

Screens

Washi

All screens in the Washi collections can be used for Panel and it is possible to combine several types in one product and screen. The maximum segment width is from 245 to 300 cm.

Due to its increased durability, LX-Washi is perfect as a cabinet door or a room divider.

Textures

All fabrics in the Textures collections have B1 class fire resistance and are suited for Panel. Translucent and semi-translucent canvases create a special and functional effect.

Fabrics of the Washi and Textures collections can be combined within one product.

Panel track

Wood & Washi Panel is finished at the top with Velcro. This secures the panels to an optional carriage. This universal method makes Panel suitable for a large number of types and brands of tracks and carriages.

Wood & Washi offers Silent-Gliss panel tracks and carriages to order. The tracks have 2 to 5 operational channels and can be equipped with manual and electric drives. The individual panels can be installed separately from each other or connected. Silent-Gliss panel tracks are by default supplied with manual movement and tensioners for ceiling mounting. (Design) wall supports can be ordered as an option.

Perforation

To achieve playful effects and transparency, Washi and Washi Specials can be perforated. Wood & Washi offers four different cutting shapes, each with its own light effect.



Ribs

There is a double-sided 25 mm rib on the bottom of each panel. The top is finished with Velcro at the back and a 25 mm rib at the front as standard. On request, the top of the panel can be completed with a Velcro fastener only.

Middle ribs can be 10 mm or 25 mm wide. LX-Washi is only supplied with 25 mm ribs. Middle ribs are always double-sided.

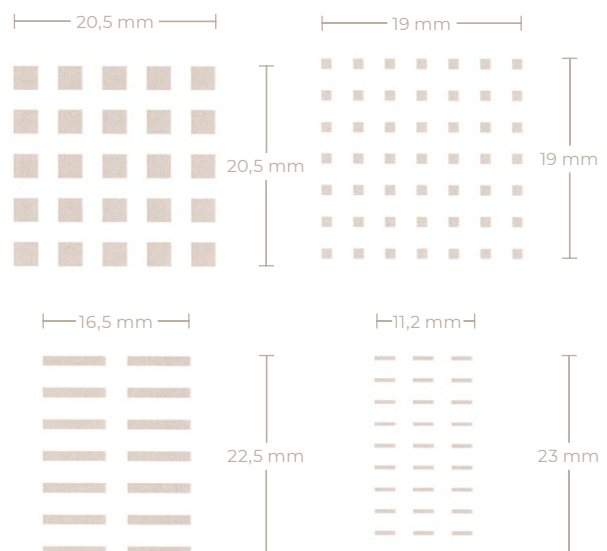

Prints

Wood & Washi Prints

Wood & Washi prints allow the application of various standard images or effects on Washi Originals light-colored screens. The Wood & Washi classic Sparrow is an example.

Custom design

To make the product even more individual, digital prints may be added to a Washi material. For example, logos, unique colors (RAL, CMYK, Pantone), and/or a customized pattern or design can be printed. Wood & Washi will gladly help to choose. A professional and motivated team is available for support.

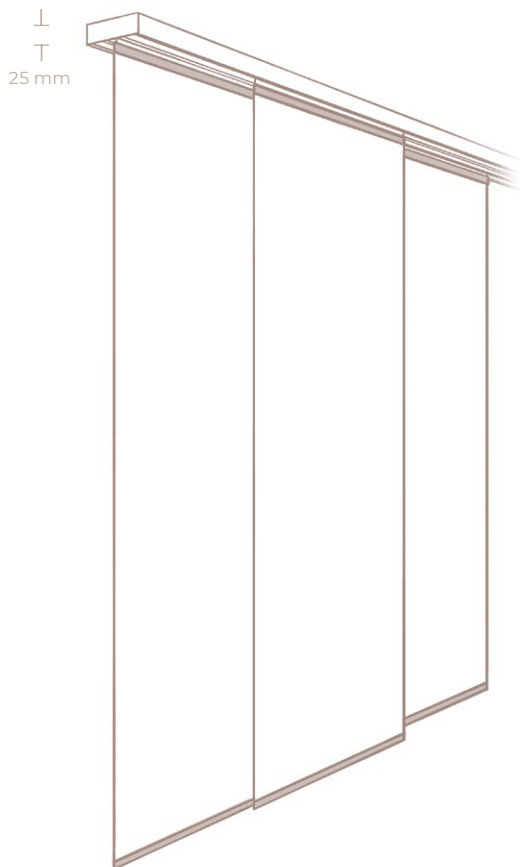

Option

Pull rod

A pull rod may be included in the delivery scope to move the panels without contact with the canvas. Pull rods are produced by Wood & Washi from high-quality anodized aluminum. The rod is 125 cm long as standard; any other desired length can be supplied at request. Pull rods are available in aluminum and white-colored.

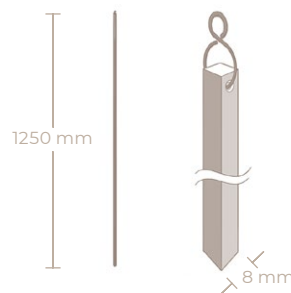

Sizes

Precise dimension and final product size

- When ordering a panel track, 10 mm clearance is subtracted from the exact dimension by default.
- When ordering panels and track with an indication of the ceiling to floor size, Wood & Washi will, by default, leave a gap of 2 cm to the floor.
- When ordering panels without tracks, nothing is subtracted: the dimensions requested are the produced dimensions.
- By default, the overlap of panels is 5 cm.

Maximum and minimum system sizes available are shown in the price list. Non-standard sizes are available at request.

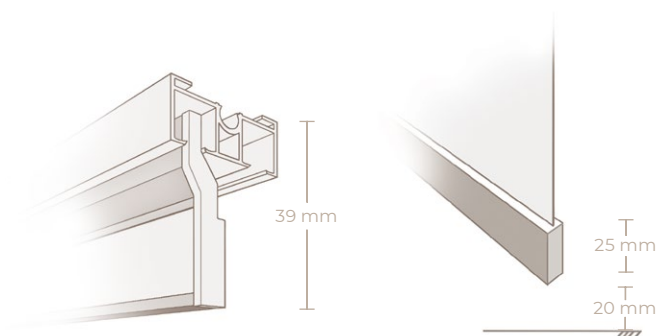

2 channel panel track

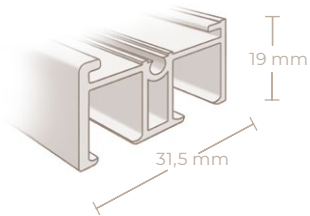

Design support

Colors: aluminum and white

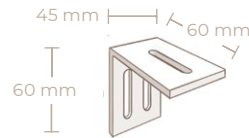

3 channel panel track

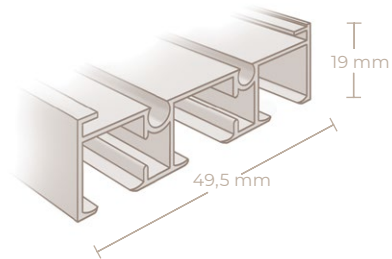

Design support

Colors: aluminum and white

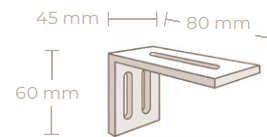

4 channel panel track

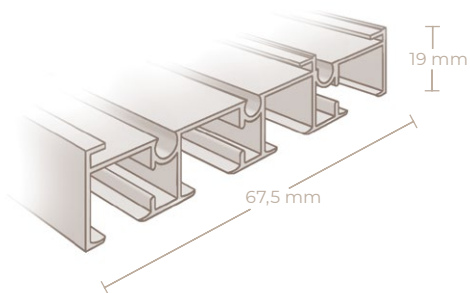

Design support

Colors: aluminium and white

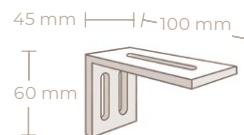

5 channel panel track

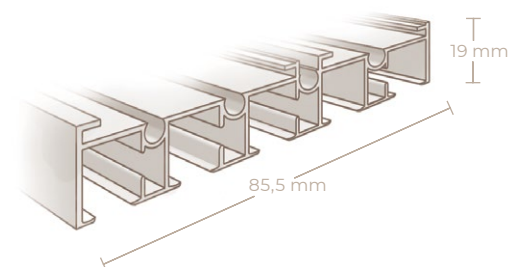

Design support

Colors: aluminium and white

